



Treatment of perfluorooctane sulfonic acid (PFOS) using a large-scale sonochemical reactor



Vitthal L. Gole^{a,c}, Asher Fishgold^a, Reyes Sierra-Alvarez^b, Pierre Deymier^a, Manish Keswani^{a,*}

^a Department of Materials Science and Engineering, The University of Arizona, P.O. Box 210012, Tucson, AZ, USA

^b Department of Chemical and Environmental Engineering, The University of Arizona, P.O. Box 210011, Tucson, AZ, USA

^c Department of Chemical Engineering, AISSMS College of Engineering, Kennedy Road, Pune 411 001, Maharashtra, India

ARTICLE INFO

Keywords:

Sonochemical reactor
PFOS
Dual frequency
Cavitation yield
Megasonic frequency
Per- and polyfluorinated compounds

ABSTRACT

(Per)fluorochemicals are highly persistent in the environment and need to be treated before discharge. Sonochemical treatment is most efficient for removal of recalcitrant pollutants such as (per)fluorochemicals. Many laboratory-scale studies have highlighted the importance of sonochemical method for removal of (per)fluorochemicals. In the present work, treatment of perfluorooctane sulfonate (PFOS) using a large sonochemical reactor of 91-L capacity was investigated. The reactor was provided with nine 1-MHz and three 500-kHz transducers and variable power dissipation with maximum rating of 12,000 W. De-fluorination and mineralization of PFOS was evaluated based on release of fluoride and sulfate ions and removal of TOC for varying initial PFOS concentration and solution pH, addition of salt, and frequencies. It has been observed that release of fluoride and sulfate ions increased with an increase in initial PFOS concentration from 0.32 to 2.6 mM and a decrease in pH of the solution from 8.5 to 4.0. The maximum concentration of fluoride and sulfate ions released after 240 min of sonication was $102.2 \pm 0.2 \mu\text{M}$ and $76.6 \pm 0.1 \mu\text{M}$, respectively, for an initial PFOS concentration of 2.6 mM at pH 4. The addition of sodium chloride and sodium carbonate decreased the rate of defluorination. The present investigation is useful for the development of a sonochemical process for industrial scale operations.

1. Introduction

The lack of feasible techniques for the treatment of large volumes of water containing perfluorinated and polyfluorinated alkyl substances (PFAS) is a global concern. These compounds are highly persistent in the environment, toxic and bioaccumulative [1,2]. Perfluorooctane sulfonate (PFOS) is a fully fluorinated anion and is of particular interest because of its wide industrial utilization and environmental prevalence. PFOS is used in fire retardants and suppressant foams (aqueous film-forming foams), as surfactant additives, and in pesticides and lubricants [3]. Before stringent norms were put in place, PFOS was released in large quantities into the environment in the range of 450–2700 tons [4]. Despite the discontinued use of PFOS in firefighting foams, measured concentrations of PFOS in waste ponds generated by firefighting exercises at military air bases was as high as 9.7 mg/L [5]. PFOS is resistant to every natural degradation pathway, including photolysis, hydrolysis and microbial degradation [6]. PFOS is also a toxic and bioaccumulative contaminant, and the concentrations of PFOS found in fish exposed to contaminated water is 8850-fold higher compared to natural water [7]. Health hazards associated with PFOS and other

perfluorinated compounds are well discussed in the literature [6,8,9]. Recently (May 2016), the United States Environmental Protection Agency (US-EPA) set a new lifetime health advisory level for PFOS and PFOA combined of 70 ng/L [10].

There are several methods for removal of PFAS from the water. Biological methods are not effective due to the high recalcitrance of these fluorochemicals to microbial degradation [11]. Physical methods based on adsorption using various materials such as clays, zeolite, carbon nanotubes, activated carbon, and char have been studied by several researchers [1,8–12]. Some of the adsorbents removed 90% PFOS, but major limitations of these process are slow kinetics, low affinity for PFOS sorption, the competition of co-contaminants for adsorption sites, high sorbent costs, and the need for high-temperature incineration to destroy perfluorochemicals completely. Filtration techniques based on reverse osmosis have shown 99% removal efficiency at low energy consumption, but the major constraint is pretreatment requirement and severe reduction of permeate flux with time [13]. Sonochemical methods have unique advantages over conventional treatment methods. Complete defluorination can be attained without any pretreatment and at higher kinetic rates [8]. Sonolysis works at ambient

* Corresponding author.

E-mail address: manishk@email.arizona.edu (M. Keswani).

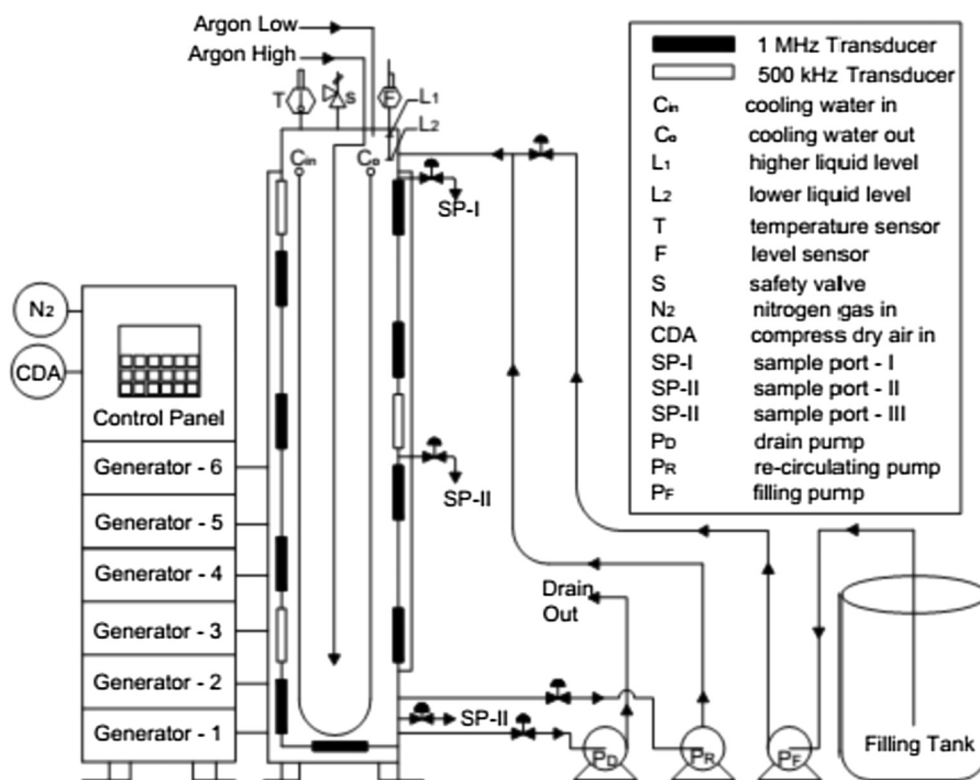

Fig. 1. Schematic view of the sonochemical reactor with a capacity of 91 L utilized for treatment of PFOS.

temperature and pressure conditions, it has less safety issues and higher kinetic rate compared to other technologies such as microwave treatment and wet air oxidation [14].

The sonochemical process depends on cavitation, a phenomenon involving generation of bubbles that expand and contract during rarefaction and compression cycles before the collapse. During bubble collapse, very high temperature (4000–10000 K) and pressure conditions are generated inside the bubble cavity [14]. These conditions are highly advantageous for degradation of toxic compounds. Major cavitation effects that contribute towards enhancing the rate of degradation include (a) pyrolysis (compounds on the surface and/or cavity of the bubbles are pyrolyzed at very high-temperature conditions), (b) reactions at gas-liquid interface (breaking bonds of long chain organic compounds), and (c) generation of hydroxyl radicals (oxidation of pollutants). Cavitation activity can be further enhanced in the presence of certain additives [15,16].

Degradation of PFOS by sonochemical treatment has been reported in various laboratory-scale studies. Moriwaki et al. reported that the half-life of PFOS was 43 min by sonochemical treatment at a frequency of 200 kHz [9]. Another work observed that the half-life for degradation of PFOS was 30 min (358 kHz) or less and complete mineralization was observed after the decomposition of the perfluorinated ring [8]. Due to its hydrophobic nature, PFOS remains on the bubble surface, and fluoride released from PFOS is dominated by the bubble surface activity [8–10]. The presence of certain solid additives such as ferrous oxide/powder, copper oxide, etc, enhances cavitation activity, and therefore the environmental matrix present in the aqueous solution can be useful for removal of PFOS [7]. Removal of PFOS has been shown to increase with an increase in power dissipation and with combination of dual frequencies. Enhanced degradation has been observed using multiple frequency combinations of 20 and 202 kHz and power dissipation of 250 W/L [4]. Our earlier work showed that degradation of PFOS increased with an increase in frequency from 500 kHz to 1 MHz and increase in initial concentration from 10 to 100 μ M [17].

Although PFOS degradation has been demonstrated in small-scale laboratory studies, studies considering the degradation of PFOS and

other PFAS in large-scale sonochemical reactors are lacking. Some previous studies have shown that large-scale sonochemical reactors can effectively degrade non-perfluorinated compounds. For example, Mhetre and Gogate [18] investigated the degradation of dichlorvos using a large-scale sonochemical reactor. They used a rectangular box type ultrasonic flow reactor (30 cm \times 30 cm \times 80 cm, useful volume of 72 L) operating at a frequency of 40 kHz, and a power of 2400 W. Investigation of large-scale sonochemical systems for degradation of PFOS is lacking due to scalability issues associated with sonochemical reactors. A key factor in the design of a sonochemical reactor is a configuration that promotes a uniform distribution of cavitation activity. Such activity depends on the number and location of transducers, frequency, the geometry of reactor and power dissipation. The efficiency of sonochemical reactor depends on the optimum selection of these parameters [14,15].

The objective of this work is to develop a dual frequency sonochemical process for effective degradation of PFOS using a large-scale multi-transducer reactor with a processing volume of 91 L. The effects of the initial concentration of PFOS, pH of the solution, salt concentration, and dual vs. single frequency have been investigated.

2. Materials and methods

2.1. Materials

Ultrapure water (18 M Ω cm) was used for the preparation of aqueous solutions for all experiments. Potassium salt of the perfluorooctane sulfonic acid (Purity: 98%; CAS #2795-39-3) was procured from Matrix Scientific (Columbia, SC, USA). Hydrochloric acid, sodium hydroxide, total ionic strength adjustment buffer (TISAB – II), sodium fluoride, sodium chloride, sodium bicarbonate, sodium sulfate and potassium hydrogen phthalate were purchased from Fisher Scientific Inc. (Springfield Township, New Jersey, USA). Compressed argon was supplied by the Cryogenics and Gas Facility (The University of Arizona, Tucson, AZ, USA). Nitrogen gas and dry air were provided by the Nano Fabrication and Processing Center (The University of Arizona).

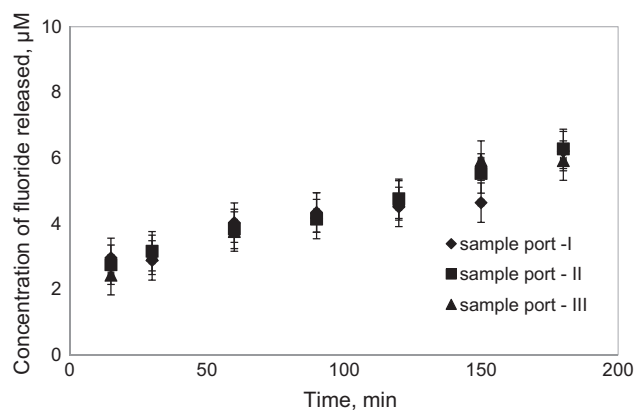

Fig. 2. Concentration of fluoride ion in samples drawn from various ports of the reactor during the degradation of PFOS (initial PFOS concentration = 0.32 mM, initial pH = 8.5, dual frequency of 1 MHz and 500 kHz). Legends: Sample port I (SP-I), rate of fluoride release: $k = 6.61 \times 10^{-3} \mu\text{M min}^{-1}$, $R^2 = 0.985$; Sample port II (SP-II), $k = 6.78 \times 10^{-3} \mu\text{M min}^{-1}$, $R^2 = 0.986$; Sample port III (SP-III), $k = 6.53 \times 10^{-3} \mu\text{M min}^{-1}$, $R^2 = 0.991$.

2.2. Sonochemical reactor

A customized sonochemical reactor (dual-frequency and multi-transducer with generators) fabricated by PCT Systems, Inc. (Fremont, CA, USA) was used in the present work. The working reaction volume of the reactor is 91 L and the dimensions are $20.9 \times 26.0 \times 175.3$ cm. The reactor is made of stainless steel and consists of 12 transducers (nine transducers with 1 MHz and three transducers with 500 kHz operating frequencies) with a cooling system for extracting the heat generated during acoustic exposure of the solution and maintaining the temperature at the desired value. The location of the transducers and the cooling coil is shown in Fig. 1. The reactor was provided with six generators, each of which controls two transducer plates or four transducer arrays (e.g. side-1 of generator controls arrays 3 & 4 (1 MHz) and arrays 1 & 2 (1 MHz)). The power supplied to the 1 MHz and 500 kHz transducers was 1100 and 700 W, respectively, with total power provided to the reactor is equal to 12,000 W (7.58 W cm^{-2}).

The calorimetric efficiency (power utilized for actual reaction to power supplied to the reactor) of the reactor was found to be 24%. A continuous supply of nitrogen gas (5–10 psi) was provided for cooling of transducers and generator electronics. Circuit breakers were available inside the control panel in the event of any fluctuations in the incoming power supply. The reactor was provided with three pumps P_D , P_R , and P_F , which were used for draining of liquid from the reactor, filling of liquid into the reactor, and recirculation of liquid in the reactor, respectively. Pump P_R was in the ‘on’ mode when the reactor was in the operational mode to maintain a uniform concentration of species in the reactor. The pumps were operated using clean, dry air (60–80 psi) supplied to the reactor. There was a good safety interlock mechanism made in the reactor in case of any failure. A re-circulating chiller (process fluid temperature range: 5 °C to 35 °C, reservoir volume: 2 L, temperature stability: ± 0.1 °C) made by Thermo Fisher Scientific (Newington, NH, USA) was used for cooling of liquid in the reactor.

2.3. Experimental methodology

Aqueous solutions of PFOS of known concentration were prepared using the potassium salt of the perfluorooctane sulfonic acid. The pH of solutions was adjusted using 1 M hydrochloric acid and 1 M sodium hydroxide solutions, as needed. The reactor was filled with PFOS solution and, subsequently, the solution was saturated with argon by bubbling with the gas for 30 min before the experiment and maintaining a blanket of this gas during the experiment. The progress of degradation was monitored by measuring the concentration of fluoride

(F^-) ion, sulfate (SO_4^{2-}) ion, total organic carbon (TOC), solution pH, and temperature as a function of time. The reactor temperature was maintained at 25 ± 3 °C by circulating cooling water and operating the reactor in a cyclic manner ‘on’ time for one hour and ‘off’ time of one hour.

2.4. Analysis

The concentration of fluoride released was measured using a fluoride ion selective electrode (ISE) (Model 9609BNWP, Thermo Scientific Inc). ISE calibration was carried out using standard solutions prepared with the various concentration of sodium fluoride (10^{-6} to 10^{-1} M). To increase/adjust ionic strength of the samples for potentiometric measurements, an equal amount of TISAB II solution (5 mL) was added to samples (5 mL). The sulfate concentration was measured by suppressed conductivity ion chromatography using a Dionex IC-3000 system (Sunnyvale, CA, USA) fitted with a Dionex IonPac AS18 analytical column (4×250 mm) and AG18 guard column (4×50 mm). The concentration of the eluent (KOH) was 17 mM, and the length of the run was 5 min. TOC analysis was performed using a Shimadzu total carbon analyzer VCSH (Columbia, MD, USA). The samples for this analysis were prepared using DI water, and the pH was adjusted to 2.0 using hydrochloric acid. The inorganic carbon was removed by sparging the samples with air. The remaining carbon was then combusted at 680 °C and analyzed. The measured and theoretical TOC concentrations were very close to a ratio of 0.95 (measured TOC/theoretical TOC).

3. Results and discussion

3.1. Concentration at different sample port locations

The reactor was provided with three sampling ports, sample port – I located just below the liquid high level (surface of the liquid, L_1), sample port – II is in the middle of reactor and sample port-III is just above drain outlet of the reactor (bottom of the liquid) (Fig. 1). Results for the degradation of PFOS (0.32 mM) at pH 8.5 and dual frequency of 1 MHz and 500 kHz are shown in Fig. 2. The concentration of fluoride ion released is about the same for samples drawn from all three ports. The concentration of fluoride released increased with time and fluoride concentration. After 180 min, the concentration of fluoride was $6.2 \pm 0.4 \mu\text{M}$, $6.3 \pm 0.6 \mu\text{M}$ and $6.0 \pm 0.5 \mu\text{M}$ for samples collected from ports I, II and III, respectively. The rate of fluoride release was nearly the same rate for all ports. The uniform concentration is related to the chemical and physical effects of cavitation. These effects are useful for improving the rate of chemical processing and consistent concentration in the reactor. Physical effects of cavitation such as micro-emulsifications and acoustic streaming are useful for enhancing mixing index.

Mixing effects depend on the distance from the transducer surface, the frequency of operation and liquid properties such as density and viscosity [14]. Mixing intensity is very high close to the transducer and decreases with increasing distance from transducer surface and with a decrease in power density. Uniform mixing is observed at higher frequencies due to higher stable cavitation activity. The number density of bubbles and mixing index depend on compression and rarefaction cycles (acoustic cycles) which increase at higher frequency operation [19]. It has been reported that for the same electrical power input and physical properties of the liquid, the mixing index increases by 10% in a sonochemical reactor (1.7 MHz) compared to a conventional stirred tank reactor [2]. Physical effects of cavitation are not only limited to mixing index but also enhance diffusivity. Effective diffusivity of potassium iodide in water increases from 0.2×10^{-3} to $0.7 \times 10^{-3} \text{ m}^2/\text{s}$ for an increase in power from 20 to 70 W [19].

Since, the concentration of fluoride released was the same for samples collected from ports I, II and III, samples from port – II were

collected to monitor the progress of degradation of PFOS for further study.

3.2. Effect of initial PFOS concentration

The efficiency of the sonochemical process depends on the concentration of pollutants around/near the vicinity of the cavitation bubble and the properties of the pollutants [14]. Hydrophobic compounds adsorb preferably at the bubble/liquid interface, and hydrophilic compounds are dissolved easily in an aqueous medium and remain in the bulk of the solution. During the acoustic cycle, compounds with higher Henry constant occupy the space inside the bubble cavity, while compounds with lower Henry constant stay in bulk. During bubble collapse, compounds inside the bubble get pyrolyzed (due to extreme temperature and pressure conditions attained inside the bubble). Radicals formed during pyrolysis react with compounds either adsorbed to the bubble surface or present in the bulk of the solution [4,8,9,20,21]. The intensity of cavitation activity depends on the initial concentration of the solution, so the selection of optimum concentration of a pollutant is highly significant.

The effect of initial concentration of PFOS (0.32–5.3 mM, initial pH: 6.5) on PFOS degradation using dual frequency operation (1 MHz and 500 kHz) was examined. The concentration of fluoride and sulfate ions released as a function of time are shown in Fig. 3a and b, respectively. The results indicate that the concentration of fluoride and sulfate released increased with time for all PFOS concentrations tested. The concentration of fluoride ions released increased with increasing initial

PFOS concentration. The concentration of fluoride ions released at 0.32, 2.6 and 5.3 mM after 240 min was $44.9 \pm 0.5 \mu\text{M}$ (14.2% fluoride released), $75.4 \pm 0.4 \mu\text{M}$ (2.9%) and $98.6 \pm 0.2 \mu\text{M}$ (2%), respectively. The concentration of sulfate ions released increased with an increase in the initial concentration of PFOS from 0.32 to 2.6 mM; further, an increase in concentration from 2.6 to 5.3 mM resulted in a decrease in the concentration of sulfate ions.

Results were further analyzed based on the removal of TOC. The TOC removed at the end of 240 min for 0.32, 2.6 and 5.3 mM PFOS was $23.5 \pm 0.6 \mu\text{M}$ (38.2% total initial TOC), $105.3 \pm 0.7 \mu\text{M}$ (23.1%) and $30.6 \pm 0.5 \mu\text{M}$ (3%), respectively. TOC removal showed a similar trend as that of sulfate ions release. Based on these results, an initial PFOS concentration of 2.6 mM was considered as optimal (in the range investigated), and further studies were conducted using this concentration.

The effect of the initial concentration on PFOS degradation can be analyzed based on the properties of this compound. PFOS consists of a perfluorinated hydrophobic chain [–C–F–] and a hydrophilic head composed of a sulfonic group [–SO₃H]. During the sonochemical process cleavage of the sulfonic group occurs, with the release of sulfate to the bulk liquid. Due to its hydrophobic nature, the fluorinated carbon chain is at the surface of the bubble cavity. During sonolysis, long chain (C–F) compounds may be broken into smaller chain compounds at the high temperature and pressure conditions attained during the collapse of the bubble (maximum temperature at bubble interface ranges from 800 to 1200 °C) [14]. The smaller chain compounds may be mineralized by hydroxyl radicals present in bulk of the solution [8,9,20,21]. The higher initial concentration of PFOS is useful for increasing the concentration of this pollutant near the vicinity of the cavitation bubble, and it may result in higher release of fluoride ions. Increasing the concentration beyond the optimum initial concentration of PFOS may prevent bubble collapse and result in lower cavitation events and fluoride release rates [17,21]. Our results are in close agreement with those previously obtained in small-scale reactor studies at 500 kHz where the PFOS degradation rates determined were $7.4 \times 10^{-4} \text{ mM min}^{-1}$, $3.6 \times 10^{-3} \text{ mM min}^{-1}$ and $6.1 \times 10^{-3} \text{ mM min}^{-1}$ for initial PFOS concentrations of 10, 100 and 460 μM , respectively [17].

3.3. Effect of pH

The pH of the solution has a significant effect on the sonochemical degradation of organic compounds [22,23]. The benefits of lower pH are a reduction of (a) recombination of hydroxyl radicals, (b) scavenging effect in the presence of carbonate and sulfates, and (c) OH deprotonation [24]. In acidic conditions, the oxidation potential of hydroxyl ([•]OH) radicals is higher ($E^0 = 2.78 \text{ V}$) compared to neutral and basic solutions ($E \leq 1.80 \text{ V}$) [22], enhancing the radical yield.

The sonochemical degradation of PFOS (initial concentration = 2.6 mM) under dual sound frequency (1 MHz and 500 kHz) was investigated at solution pH of 3.0, 4.0, 6.5 and 8.5 and results for the concentration of fluoride and sulfate released are shown in Fig. 4a and b, respectively. The results indicate that when the initial pH decreased from 8.5 to 4.0, the concentration of fluoride released after 240 min increased from 8.6 ± 0.06 to $102.2 \pm 0.02 \mu\text{M}$. With a further decrease in pH from 4.0 to 3.0, the concentration of fluoride released decreased to $69.2 \pm 0.03 \mu\text{M}$. A similar trend was observed for the concentration of sulfate released in the pH range of 3–8.5, with a concentration of sulfate released being highest at pH 4 ($76.6 \mu\text{M}$).

After 240 min of sonolysis, the concentration of fluoride released was $69.2 \pm 0.03 \mu\text{M}$ (2.6%), $102.2 \pm 0.02 \mu\text{M}$ (3.3%), $75.4 \pm 0.04 \mu\text{M}$ (2.9%) and $8.6 \pm 0.06 \mu\text{M}$ (1.8%), and the concentration sulfate released was $51.1 \pm 0.04 \mu\text{M}$ (10.6%), $76.6 \pm 0.01 \mu\text{M}$ (14.7%), $66.2 \pm 0.03 \mu\text{M}$ (12.7%) and $8.9 \pm 0.02 \mu\text{M}$ (4.5%) for pH 3.0, pH 4.0, pH 6.5 and pH 8.5, respectively. The effect of pH was analyzed based on mineralization of PFOS and in terms of TOC removal. TOC removal after 240 min was

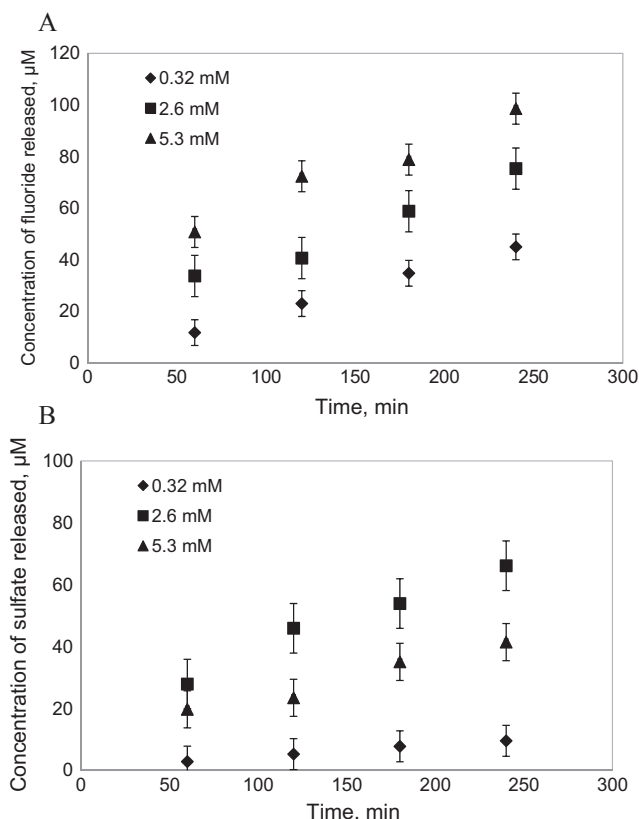

Fig. 3. Effect of initial concentration of PFOS on the rate of sonochemical degradation (initial pH = 6.5, dual frequency of 1 MHz + 500 kHz). Panel (a) Concentration of fluoride ion released at different initial PFOS concentrations: 0.32 mM (\blacklozenge), rate of fluoride release: $k = 1.86 \times 10^{-1} \mu\text{M min}^{-1}$, $R^2 = 0.991$; 2.6 mM (\blacksquare), $k = 2.38 \times 10^{-1} \mu\text{M min}^{-1}$, $R^2 = 0.978$ (\blacksquare); 5.3 mM (\blacktriangle), $k = 2.51 \times 10^{-1} \mu\text{M min}^{-1}$, $R^2 = 0.979$. Panel (b) Concentration of sulfate ion released at different initial PFOS concentrations: 0.32 mM (\blacklozenge), rate of sulfate release: $k = 1.28 \times 10^{-1} \mu\text{M min}^{-1}$, $R^2 = 0.987$; 2.6 mM (\blacksquare), $k = 3.78 \times 10^{-1} \mu\text{M min}^{-1}$, $R^2 = 0.995$ (\blacksquare); 5.3 mM (\blacktriangle), $k = 2.04 \times 10^{-1} \mu\text{M min}^{-1}$, $R^2 = 0.986$ (\blacktriangle).

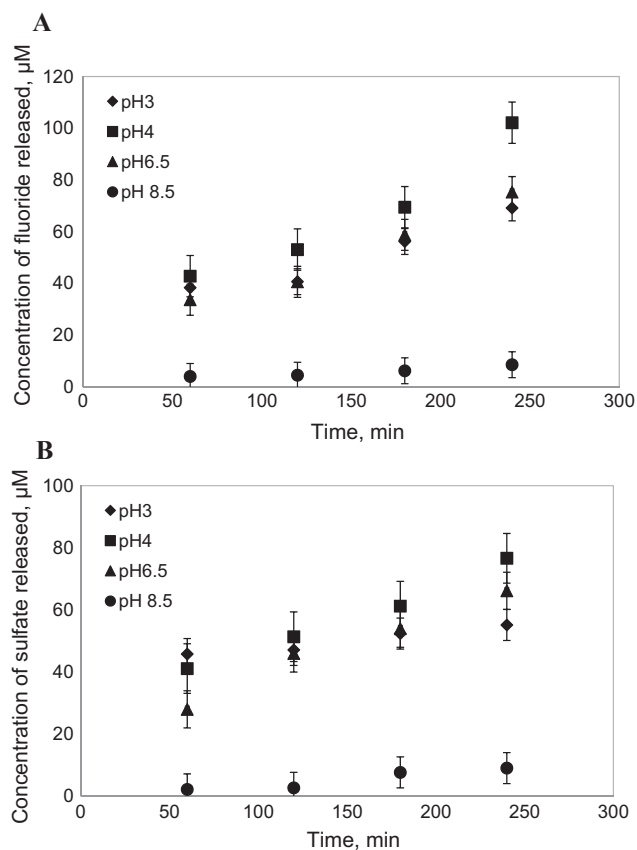

Fig. 4. Effect of pH on the sonochemical degradation of PFOS (initial PFOS concentration = 2.6 mM, dual frequency of 1 MHz + 500 kHz). Panel (a) Concentration of fluoride ion released at different initial pH values: pH 3.0 (◆), rate of fluoride release: $k = 2.37 \times 10^{-1} \mu\text{M min}^{-1}$, $R^2 = 0.997$; pH 4.0 (■), $k = 3.24 \times 10^{-1} \mu\text{M min}^{-1}$, $R^2 = 0.986$; pH 6.5 (▲), $k = 2.38 \times 10^{-1} \mu\text{M min}^{-1}$, $R^2 = 0.978$; pH 8.5 (●), $k = 2.55 \times 10^{-1} \mu\text{M min}^{-1}$, $R^2 = 0.987$. Panel (b) Concentration of sulfate ion released at different initial pH values: pH 3.0 (◆), rate of sulfate release: $k = 6.72 \times 10^{-2} \mu\text{M min}^{-1}$, $R^2 = 0.989$; pH 4.0 (■), $k = 1.94 \times 10^{-1} \mu\text{M min}^{-1}$, $R^2 = 0.991$; pH 6.5 (▲), $k = 3.78 \times 10^{-1} \mu\text{M min}^{-1}$, $R^2 = 0.995$; pH 8.5 (●), $k = 4.26 \times 10^{-2} \mu\text{M min}^{-1}$, $R^2 = 0.982$.

$92.8 \pm 0.08 \mu\text{M}$ (21.1%), $105.3 \pm 0.07 \mu\text{M}$ (23.1%), $83.9 \pm 0.04 \mu\text{M}$ (19.5%) and $35.4 \pm 0.03 \mu\text{M}$ (8.1%) for pH 3.0, 4.0, 6.5 and 8.5, respectively. TOC removal rate for pH 4.0 was observed to be higher compared to that at pH 3, pH 6.5 and 8.5. Based on these results, pH 4.0 was considered as optimum pH and used for further investigations.

PFOS is considered as a strong acid with $\text{pK}_a -3.7$ [25]. The pK_a value of PFOS is very low, and therefore the compound quickly deprotonates at all the pH values tested in this study (pH 3 or higher). Physical properties of PFOS such as higher hydrophobicity, protonation at lower pH and lower surface tension in aqueous solution make it preferentially adsorb (C–F) to the liquid/bubble interface. At lower pH, the charge of the bubble-water interface becomes more positive, which reduces bubble coalescence (increases the concentration of more bubble collapse) and attracts more oppositely charged hydrophobic compounds onto the bubble surface and enhances the rate of degradation in acidic conditions [23]. Therefore, a lower solution pH is better for higher degradation of PFOS.

Previous literature findings obtained in small-scale sonochemical reactors strongly support our large-scale reactor results. Sonochemical defluorination of ammonium perfluorooctanoate (PFOA) at 20 kHz (200 W, initial concentration: 46 μM , temperature: 25 °C time: 120 min) was faster at pH 6 compared to pH 7 and pH 10 [20]. Sonochemical degradation of PFOA (initial concentration: 0.12 mM, temperature: 25 °C, frequency: 354 kHz, time: 120 min) showed that complete defluorination occurred in 90 min at pH 4.3 compared to 120 min at pH

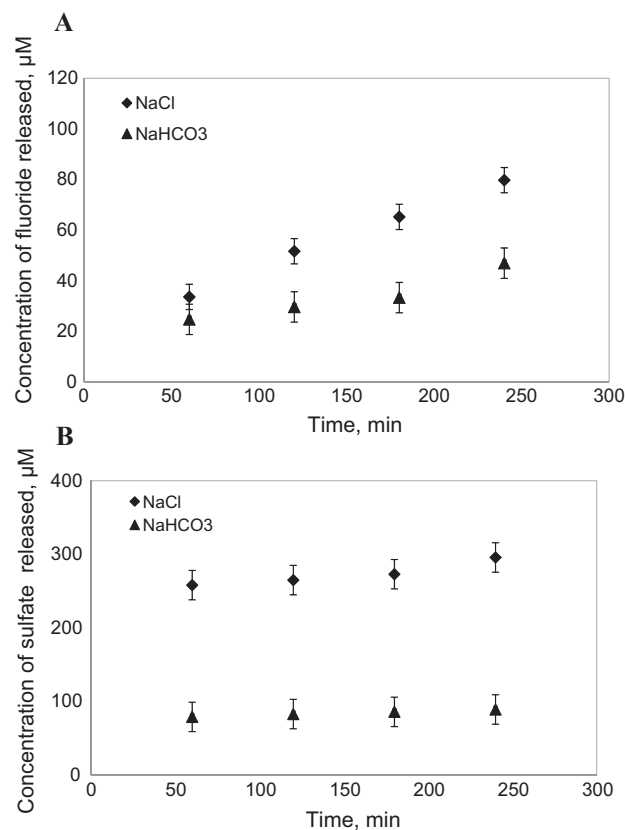

Fig. 5. Effect of addition of salts on the degradation of PFOS (initial PFOS concentration = 2.6 mM, dual frequency of 1 MHz + 500 kHz). Panel (a) Fluoride ion released when salt was added: Effect (◆) 1% NaCl, rate of fluoride release; $k = 2.53 \times 10^{-1} \mu\text{M min}^{-1}$, $R^2 = 0.996$; (▲) 1% NaHCO₃; $k = 1.17 \times 10^{-1} \mu\text{M min}^{-1}$, $R^2 = 0.984$. Panel (b) Concentration of sulfate ion released when salt was added: Effect (◆) 1% NaCl, rate of sulfate release, $k = 2.53 \times 10^{-1} \mu\text{M min}^{-1}$, $R^2 = 0.996$; (▲) 1% NaHCO₃, $k = 1.17 \times 10^{-1} \mu\text{M min}^{-1}$, $R^2 = 0.984$.

7.3 and pH 11.1 [24]. The sonication-assisted decomposition efficiency of PFOA (40 kHz and power of 150 kW, initial concentration: 170 μM) was 62.4% and 56.7% after 120 min for pH 3.9 and 10.1, respectively [23].

3.4. Effect of addition of salts

Most of the degradation of PFOS is likely to occur at the gas-bubble interface. The presence of sodium chloride and sodium bicarbonate in the solution may increase the sonochemical degradation of PFOS. Increasing ionic strength has been shown to enhance transport of hydrophobic pollutants from the bulk solution to the gas-bubble interface, thereby enhancing their degradation [26–28].

We have studied the effect of the addition of sodium chloride and sodium bicarbonate at 1% (w/w) concentration on the degradation of PFOS (initial concentration: 2.6 mM, pH 4.0, dual frequencies combination of 500 kHz + 1 MHz). The results are shown in Fig. 5a and b.

The concentration of fluoride released after 240 min of sonolysis was $79.7 \pm 0.4 \mu\text{M}$ in the presence of sodium chloride and $46.9 \pm 0.5 \mu\text{M}$ (pH 4) in the presence of sodium bicarbonate. The concentration of sulfate released in the presence of sodium chloride and sodium bicarbonate was $295.8 \pm 0.3 \mu\text{M}$ $89.3 \pm 0.1 \mu\text{M}$, respectively. TOC removed was $136.9 \pm 0.5 \mu\text{M}$ in the presence of NaCl and $167.8 \pm 0.6 \mu\text{M}$ in the presence of NaHCO₃. The results show that the concentration of fluoride and sulfate ions released was higher in the presence of sodium chloride. TOC removal rate was maximum for sodium bicarbonate-containing solutions. When these results are compared with sonolysis in the absence of salt, the concentration of fluoride

ion released was reduced from 102.2 ± 0.2 to $79.7 \pm 0.4 \mu\text{M}$ (NaCl), the concentration of sulfate ion released increased from 76.6 ± 0.1 and $295.8 \pm 0.3 \mu\text{M}$ (NaCl), and TOC removal increased from 83.9 ± 0.4 to 167.8 ± 0.6 (NaHCO₃). It appears that sodium chloride was useful to promote the release of sulfate ions while the addition of sodium bicarbonate enhanced TOC removal. The addition of any of these salts had a hindering effect on the release of fluoride ions [26].

The addition of salts can increase the hydrophobicity, surface tension and ionic strength of the aqueous phase and decrease the vapor pressure which, may cause the bubbles to collapse more violently resulting in concentration of hydroxyl ions and these ions may be useful for removal of TOC [26,27]. The following chemical reactions are expected to occur in the presence of sodium bicarbonate (reactions (1)–(6)):

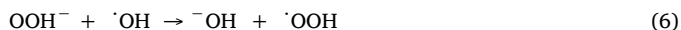
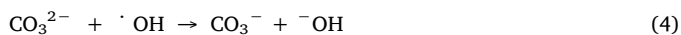
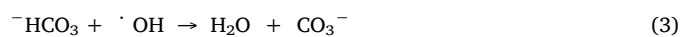

Eqs. (3), (4) and (6) show that addition of sodium bicarbonate has a scavenging effect on hydroxyl ion formation during cavity collapse and also forms carbon dioxide, which may dampen cavitation effects leading to a decrease in the concentration of fluoride ions released [26,27].

3.5. Effect of frequency

Cavitation activity in the sonochemical reactor is highly dependent on the frequency of operation. The higher frequency (megasonic) operation is recommended for treatment of wastewater treatment and chemical synthesis. Selection of frequency depends on the nature and volume of pollutants. Megasonic operations are suitable for large-scale operations due to stable and uniform cavitation activity formed at megasonic compared to lower frequencies [14]. Cavitation activity can be further enhanced using a combination of frequencies [29] which can improve the overall cavitation activity with higher efficiencies for the treatment of wastewater and chemical processing. The production of cavitation bubble volume fractions is more for dual frequency compared single frequency operations [30,31].

The effect of a single (1 MHz) and dual frequency (1 MHz + 500 kHz) on PFOS degradation (initial concentration: 2.3 mM, initial pH 4.0) was studied. The reactor is equipped with nine transducers operating at 1 MHz (1100 W power) and three transducers with operating frequency of 500 kHz (700 W). Total power for single frequency operation (1 MHz) was 9900 W, and 1200 W dual frequency operation (500 kHz and 1 MHz). The location of transducers and other details of the reactor are shown in Fig. 1. Results of single frequency (1 MHz) and dual frequency operation (1 MHz and 500 kHz) shown in Fig. 6a and b, respectively, indicated that dual frequency operation is useful in increasing the release of fluoride ions while single frequency operation is useful to enhance sulfate release. After 240 min, the concentration of fluoride released was $85.7 \pm 0.3 \mu\text{M}$ and $102.2 \pm 0.2 \mu\text{M}$, sulfate released was 76.8 ± 0.1 and $76.6 \pm 0.1 \mu\text{M}$, and TOC removal was 25.2 ± 0.2 and $83.9 \pm 0.4 \mu\text{M}$, for single and dual frequency operation, respectively.

The effect of frequency was further analyzed based on the cavitation yield (concentration of ions released/TOC removed per kJ of energy utilized). The cavitation yield for fluoride release was $5.9 \pm 0.2 \text{ nM/kJ}$ and $6.0 \pm 0.5 \text{ nM/kJ}$, for sulfate release was

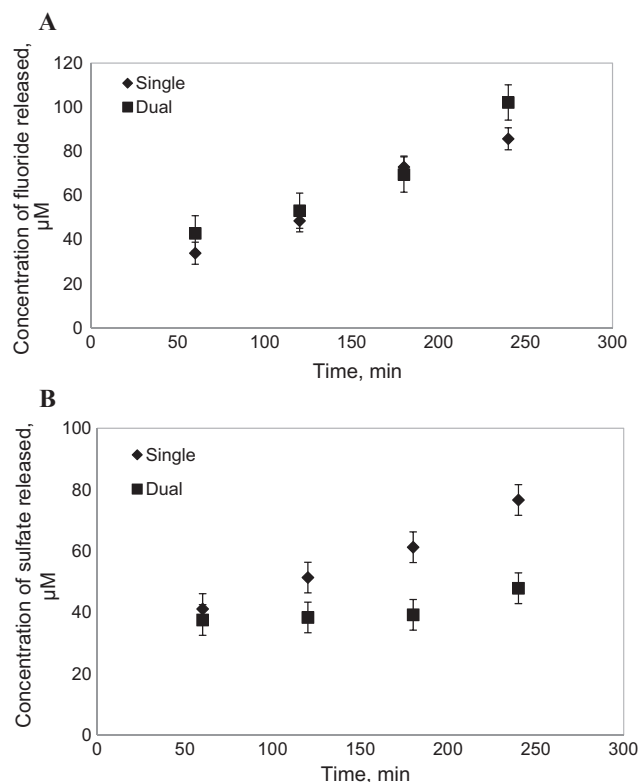

Fig. 6. Effect of acoustic frequency on the degradation of PFOS (initial concentration of PFOS: 2.6 mM, pH of initial solution: 4.0). Panel (a) Concentration of fluoride ion released using: single frequency of 1 MHz (◆); rate of fluoride release: $k = 3.00 \times 10^{-1} \mu\text{M min}^{-1}$, $R^2 = 0.986$; and dual frequency of 1 MHz and 500 kHz (■), $k = 3.24 \times 10^{-1} \mu\text{M min}^{-1}$, $R^2 = 0.986$. Panel (b) Concentration of sulfate ion released; using: single frequency (◆), rate of sulfate release: $k = 1.94 \times 10^{-1} \mu\text{M min}^{-1}$, $R^2 = 0.986$; and dual frequency (■), $k = 1.94 \times 10^{-1} \mu\text{M min}^{-1}$, $R^2 = 0.991$.

$4.4 \pm 0.3 \text{ nM/kJ}$ and $5.4 \pm 0.3 \text{ nM/kJ}$, and for TOC removal was 4.9 ± 0.4 and $1.8 \pm 0.7 \text{ nM/kJ}$ for dual and single frequency operations, respectively. The cavitation yield results obtained indicate that dual frequency does not show any significant effect on the concentration of fluoride and sulfate released, but it is beneficial for TOC removal.

Based on results of fluoride and sulfate released and cavitation yield, it is clear that dual frequency operation did not enhance the release rate of these ions. The increase in the concentration of fluoride ions released was likely due to the increase of power intensity to the system from 9900 W to 12000 W for 1 MHz and dual-frequency operation, respectively. In dual-frequency operation, bubble coalescence (driven by Bjerknes forces) reduces the number of bubbles in the system [14]. Another drawback of dual frequency operation is the wave's cancellation effect from different frequencies, which may reduce the cavitation activity [29–32].

Study of the acoustic degradation of PFOS using 610 kHz, 202 kHz and 20 kHz frequencies and the combination of 20 + 610 kHz and 20 + 202 kHz showed that an enhancement in PFOS degradation was observed when using dual frequency operation, with maximum degradation at a dual frequency of 20 + 202 kHz [4].

Scalability is one of the foremost challenges associated with sonochemical technology. It may be due to the maximum concentration of cavitation activity near the transducer surface. There are no previous studies considering treatment of PFOS using large-scale sonochemical reactor. Work on the large-scale sonochemical reactors is mainly restricted to mapping cavitation activity in the reactor based on iodine release measurements, and operating capacity is not more than 40–50 L [14,15,33–35]. The present work confirms that megasonic sonochemical treatment in a large-scale reactor is useful for degradation of PFOS.

4. Conclusions

This study demonstrated the effectiveness of sonochemical technology using a large-scale reactor system for the treatment of highly persistent PFOS. The main challenge associated with the design of the sonochemical reactor is to attain uniform distribution of cavitation activity in the reactor. The sonochemical reactor efficiency for degradation of PFOS was monitored in terms of fluoride and sulfate release and TOC removal. Fluoride and sulfate release efficiency increased with increasing initial PFOS concentration from 0.32 mM to 2.6 mM and decrease in pH from 8.5 to 4.0. The addition of salt had an adverse effect on fluoride release. Single frequency operation was found to be more efficient compared to dual frequency operation. Overall, a multi-transducers sonochemical reactor of 91 L capacity was found to be effective for the treatment of environmentally recalcitrant compounds.

Acknowledgements

Authors are grateful to Air Force Civil Engineering Center, under the project number FA8903-13-C-0011 for providing financial support to this project.

References

- [1] J.W. Martin, B.J. Asher, S. Beesoon, J.P. Benskin, M.S. Ross, *J. Environ. Monitor.* 12 (2010) 1979–2004.
- [2] T.F. Yusaf, D.R. Buttsworth, *Ultrason. Sonochem.* 14 (2007) 266–274.
- [3] K.J. Hansen, H. Johnson, J. Eldridge, J. Butenhoff, L. Dick, *Environ. Sci. Technol.* 36 (2002) 1681–1685.
- [4] T. Campbell, M.R. Hoffmann, *Sep. Purif. Technol.* 156 (2015) 1019–1027.
- [5] M. Mallavarapu, R. Naidu, *Environ. Monit. Assess.* 187 (2015) 1–8.
- [6] C.D. Vecitis, H. Park, J. Cheng, B.T. Mader, M.R. Hoffmann, *J. Phys. Chem. C* 112 (2008) 16850–16857.
- [7] J. Cheng, S. Lv, S. Nie, J. Liu, S. Tong, N. Kang, *Aquat. Toxicol.* 176 (2016) 45–52.
- [8] C.D. Vecitis, H. Park, J. Cheng, B.T. Mader, M.R. Hoffmann, *Front. Environ. Sci. Eng. China* 3 (2009) 129–151.
- [9] H. Moriwaki, Y. Takagi, M. Tanaka, K. Tsuruho, K. Okitsu, Y. Maeda, *Environ. Sci. Technol.* 39 (2005) 3388–3392.
- [10] D. Brooke, A. Footitt, T. Anwaogu, *Environmental Risk Evaluation Report: Perfluorooctanesulphonate (PFOS)*, U.S. Environment Agency's Science Group, 2014, pp. 1–96.
- [11] V.A.A. Espana, M. Mallavarapu, R. Naidu, *Environ. Technol. Innov.* 4 (2015) 168–181.
- [12] L.A.P. Thi, H.T. Do, S.L. Lo, *Ultrason. Sonochem.* 21 (2014) 1875–1880.
- [13] O.S. Arvaniti, A.S. Stasinakis, *Sci. Total Environ.* 524–525 (2015) 81–92.
- [14] P.R. Gogate, V.S. Sutkar, A.B. Pandit, *Chem. Eng. J.* 166 (2011) 1066–1082.
- [15] T.J. Mason, *Ultrason. Sonochem.* 7 (2000) 145–149.
- [16] M. Keswani, S. Raghavan, P. Deymier, *Microelectron. Eng.* 102 (2013) 91–97.
- [17] L.R. Freire, R. Balachandran, R.S. Alvarez, M. Keswani, *J. Hazard. Mater.* 300 (2015) 662–669.
- [18] A.S. Mhetre, P.R. Gogate, *Chem. Eng. J.* 258 (2014) 69–76.
- [19] F. Parvizian, M. Rahimi, M. Faryadi, *Chem. Eng. Process* 50 (2011) 732–740.
- [20] F. Hao, W. Guo, A. Wang, Y. Leng, H. Li, *Ultrason. Sonochem.* 21 (2014) 554–558.
- [21] C.D. Vecitis, H. Park, J. Cheng, B.T. Mader, M.R. Hoffmann, *Surfactants, J. Phys. Chem. A* 112 (2008) 4261–4270.
- [22] Z. Wei, R. Spinney, R. Ke, Z. Yang, R. Xiao, *Environ. Chem. Lett.* 14 (2016) 163–182.
- [23] Y.C. Lee, M.J. Chen, C.P. Huang, J. Kuo, S.L. Lo, *Ultrason. Sonochem.* 31 (2016) 499–505.
- [24] J.C. Lin, S.L. Lo, C. Yao Hu, Yu-Chi Lee, Jeff Kuo, *Ultrason. Sonochem.* 22 (2015) 542–547.
- [25] D. Brooke, A. Footitt, T. Nwaogu, *Environmental risk evaluation report: Perfluorooctanesulphonate (PFOS): Environment Agency Wallingford*, 2004.
- [26] S. Merouani, O. Hamdaoui, F. Saoudi, M. Chiha, *J. Hazard. Mater.* 175 (2010) 593–599.
- [27] N. Golash, P.R. Gogate, *Ultrason. Sonochem.* 19 (2012) 1051–1060.
- [28] Md.H. Uddina, B. Nanzaic, K. Okitsu, *Ultrason. Sonochem.* 28 (2016) 144–149.
- [29] A. Brochie, F. Grieser, M. Ashokkumar, *J. Phys. Chem. C* 112 (2008) 10247–10250.
- [30] Y. Son, M. Lim, M. Cui, J. Khim, *Jpn. J. Appl. Phys.* 49 (2010) 2–4.
- [31] G.Y. Pee, J.F. Rathman, L.K. Weavers, *Ind. Eng. Chem. Res.* 43 (2004) 5049–5056.
- [32] T. Suzuki, K. Yasui, K. Yasuda, Y. Iida, T. Tuziuti, T. Torii, M. Nakamura, *Res. Chem. Intermed.* 30 (2004) 703–711.
- [33] H. Destailats, T.M. Lesko, *Ind. Eng. Chem. Res.* 40 (2001) 3855–3860.
- [34] Y. Asakura, K. Yasuda, D. Kato, Y. Kojima, S. Koda, *Chem. Eng. J.* 139 (2008) 339–343.
- [35] Y. Son, M. Lim, J. Khim, *Ultrason. Sonochem.* 16 (2009) 552–556.